



Sand papers, abrasive clothes

Self-adhesive sand papers and sand papers with velcro

For drill machines and anglegriders

5997708100024 Ø 105 Self-adhesive sand paper, mixed / 3 pcs
 5997708100116 Ø 105 Self-adhesive sand paper P60 / 3 pcs
 5997708100123 Ø 105 Self-adhesive sand paper P80 / 3 pcs
 5997708100130 Ø 105 Self-adhesive sand paper P100 / 3 pcs

5997708106651 Ø 105 Self-adhesive sand paper P60 / 30 pcs
 5997708106668 Ø 105 Self-adhesive sand paper P80 / 30 pcs
 5997708106675 Ø 105 Self-adhesive sand paper P100 / 30 pcs
 5997708106682 Ø 105 Self-adhesive sand paper, mixed / 30 pcs

5997708100147 Ø 115 Self-adhesive sand paper, mixed / flex / 3 pcs
 5997708100154 Ø 115 Self-adhesive sand paper P60 / flex / 3 pcs
 5997708100161 Ø 115 Self-adhesive sand paper P80 / flex / 3 pcs
 5997708100178 Ø 115 Self-adhesive sand paper P100 / flex / 3 pcs

For handgrinding tools:

5997708100031 Self-adhesive sand paper, mixed / 3-3 pcs
 5997708100185 Self-adhesive sand paper, P60 / 3-3 pcs
 5997708100192 Self-adhesive sand paper, P80 / 3-3 pcs
 5997708100208 Self-adhesive sand paper, P100 / 3-3 pcs

Sand paper with velcro

For drill machines and anglegriders

5997708100543 Ø 125 Sand paper with velcro P60 / 3 pcs
 5997708100550 Ø 125 Sand paper with velcro P80 / 3 pcs
 5997708100567 Ø 125 Sand paper with velcro P100 / 3 pcs
 5997708101342 Ø 125 Sand paper with velcro, mixed / 3 pcs

5997708105487 Ø 125 Sand paper with velcro P60 / 30 pcs
 5997708105494 Ø 125 Sand paper with velcro P80 / 30 pcs
 5997708105500 Ø 125 Sand paper with velcro P100 / 30 pcs
 5997708109188 Ø 125 Sand paper with velcro, mixed / 30 pcs / L

5997708107290 Ø 115 Sand paper with velcro P60 / 3 pcs
 5997708107306 Ø 115 Sand paper with velcro P80 / 3 pcs
 5997708107313 Ø 115 Sand paper with velcro P100 / 3 pcs
 5997708107320 Ø 115 Sand paper with velcro, mixed / 3 pcs

5997708107337 Ø 115 Sand paper with velcro P60 / 30 pcs
 5997708107344 Ø 115 Sand paper with velcro P80 / 30 pcs
 5997708107351 Ø 115 Sand paper with velcro P100 / 30 pcs
 5997708109172 Ø 115 Sand paper with velcro, mixed / 30 pcs

5997708109973 Ø 115 Abrasive cloth with velcro P60 / 30 pcs
 5997708109980 Ø 115 Abrasive cloth with velcro P80 / 30 pcs
 5997708109997 Ø 115 Abrasive cloth with velcro P100 / 30 pcs
 5997708110009 Ø 115 Abrasive cloth with velcro, mixed / 30 pcs

5997708110016 Ø 125 Abrasive cloth with velcro P60 / 30 pcs
 5997708110023 Ø 125 Abrasive cloth with velcro P80 / 30 pcs
 5997708110030 Ø 125 Abrasive cloth with velcro P100 / 30 pcs
 5997708110047 Ø 125 Abrasive cloth with velcro, mixed / 30 pcs

5997708107368 Ø 125 Sand paper with velcro P60 / 3 pcs / L
 5997708107375 Ø 125 Sand paper with velcro P80 / 3 pcs / L
 5997708107382 Ø 125 Sand paper with velcro P100 / 3 pcs / L
 5997708107399 Ø 125 Sand paper with velcro P60 / 30 pcs / L
 5997708107405 Ø 125 Sand paper with velcro P80 / 30 pcs / L
 5997708107412 Ø 125 Sand paper with velcro P100 / 30 pcs / L

For deltagrinder.

5997708106705 96 Triangle sand paper with velcro P40 / 3 pcs
 5997708106712 96 Triangle sand paper with velcro P60 / 3 pcs
 5997708106729 96 Triangle sand paper with velcro P80 / 3 pcs
 5997708106736 96 Triangle sand paper with velcro P100 / 3 pcs
 5997708106743 96 Triangle sand paper with velcro P120 / 3 pcs
 5997708109195 96 Triangle sand paper with velcro, mixed / 3 pcs



Sand papers, abrasive clothes

5997708106750 96 Triangle sand paper with velcro P40/3 pcs/L
 5997708106767 96 Triangle sand paper with velcro P60/3 pcs/L
 5997708106774 96 Triangle sand paper with velcro P80/3 pcs/L
 5997708106781 96 Triangle sand paper with velcro P100/3 pcs/L
 5997708106798 96 Triangle sand paper with velcro P120/3 pcs/L
 5997708109379 96 Triangle sand paper with velcro mixed/3 pcs/L

5997708106804 96 Triangle sand paper with velcro P60/30 pcs
 5997708106811 96 Triangle sand paper with velcro P80/30 pcs
 5997708106828 96 Triangle sand paper with velcro P100/30 pcs
 5997708109201 96 Triangle sand paper with velcro, mixed/30 pcs

5997708106835 96 Triangle sand paper with velcro P60/30 pcs/L
 5997708106842 96 Triangle sand paper with velcro P80/30 pcs/L
 5997708106859 96 Triangle sand paper with velcro P100/30 pcs/L
 5997708109218 96 Triangle sand paper with velcro, mixed/30 pcs/L

5997708106866 105 Triangle sand paper with velcro P40/3 pcs
 5997708106873 105 Triangle sand paper with velcro P60/3 pcs
 5997708106880 105 Triangle sand paper with velcro P80/3 pcs
 5997708106897 105 Triangle sand paper with velcro P100/3 pcs
 5997708106903 105 Triangle sand paper with velcro P120/3 pcs
 5997708109225 105 Triangle sand paper with velcro, mixed/3 pcs

5997708106910 105 Triangle sand paper with velcro P40/3 pcs/L
 5997708106927 105 Triangle sand paper with velcro P60/3 pcs/L
 5997708106934 105 Triangle sand paper with velcro P80/3 pcs/L
 5997708106941 105 Triangle sand paper with velcro P100/3 pcs/L
 5997708106958 105 Triangle sand paper with velcro P120/3 pcs/L
 5997708109232 105 Triangle sand paper with velcro, mixed/3 pcs/L

5997708106965 105 Triangle sand paper with velcro P60/30 pcs
 5997708106972 105 Triangle sand paper with velcro P80/30 pcs
 5997708106989 105 Triangle sand paper with velcro P100/30 pcs
 5997708109249 105 Triangle sand paper with velcro, mixed/30 pcs

5997708106996 105 Triangle sand paper with velcro P60/30 pcs/L
 5997708107009 105 Triangle sand paper with velcro P80/30 pcs/L
 5997708107016 105 Triangle sand paper with velcro P100/30 pcs/L
 5997708109256 105 Triangle sand paper with velcro, mixed/30 pcs/L

5997708107023 107 Triangle sand paper with velcro P40/3 pcs/L
 5997708107030 107 Triangle sand paper with velcro P60/3 pcs/L
 5997708107047 107 Triangle sand paper with velcro P80/3 pcs/L
 5997708107054 107 Triangle sand paper with velcro P100/3 pcs/L
 5997708107061 107 Triangle sand paper with velcro P120/3 pcs/L

5997708107078 107 Triangle sand paper with velcro P60/30 pcs/L
 5997708107085 107 Triangle sand paper with velcro P80/30 pcs/L
 5997708107092 107 Triangle sand paper with velcro P100/30 pcs/L

**We can produce this product
 in a wished size and anality.**

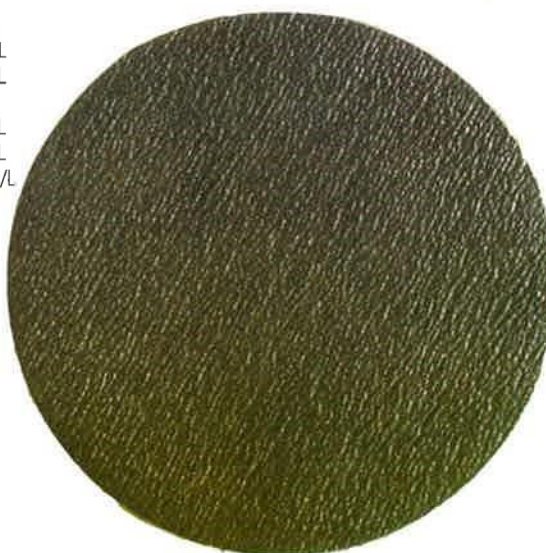

Sand papers, abrasive clothes

Sand paper and clothes in Rolls



5997708111297 120 Sand paper P30 / 50m
 5997708111303 120 Sand paper P36 / 50m
 5997708102196 120 Sand paper P40 / 50m
 5997708111310 120 Sand paper P50 / 50m
 5997708102202 120 Sand paper P60 / 50m
 5997708111327 120 Sand paper P70 / 50m
 5997708101434 120 Sand paper P80 / 50m
 5997708100727 120 Sand paper P100 / 50m
 5997708111334 120 Sand paper P120 / 50m
 5997708111341 120 Sand paper P150 / 50m

5997708110436 120 Sand paper P40 / 5m
 5997708110443 120 Sand paper P60 / 5m
 5997708110450 120 Sand paper P80 / 5m
 5997708110467 120 Sand paper P100 / 5m
 5997708110474 120 Sand paper P120 / 5m

5997708111235 120 Abrasive cloth P30 / 50m
 5997708111242 120 Abrasive cloth P36 / 50m
 5997708102455 120 Abrasive cloth P40 / 50m
 5997708111259 120 Abrasive cloth P50 / 50m
 5997708102462 120 Abrasive cloth P60 / 50m
 5997708111266 120 Abrasive cloth P70 / 50m
 5997708102479 120 Abrasive cloth P80 / 50m
 5997708102486 120 Abrasive cloth P100 / 50m
 5997708111273 120 Abrasive cloth P120 / 50m
 5997708111280 120 Abrasive cloth P150 / 50m

5997708110481 120 Abrasive cloth P40 / 5m
 5997708110498 120 Abrasive cloth P60 / 5m
 5997708110504 120 Abrasive cloth P80 / 5m
 5997708110511 120 Abrasive cloth P100 / 5m
 5997708110528 120 Abrasive cloth P120 / 5m

5997708111358 200 Abrasive cloth P30 / 25m
 5997708111365 200 Abrasive cloth P36 / 25m
 5997708103223 200 Abrasive cloth P40 / 25m
 5997708111372 200 Abrasive cloth P50 / 25m
 5997708103230 200 Abrasive cloth P60 / 25m
 5997708111389 200 Abrasive cloth P70 / 25m
 5997708103247 200 Abrasive cloth P80 / 25m
 5997708103254 200 Abrasive cloth P100 / 25m
 5997708111396 200 Abrasive cloth P120 / 25m
 5997708111402 200 Abrasive cloth P150 / 25m

Sanding belts

5997708107580 40x303 Sanding belt P40 / 3 pcs
 5997708107597 40x303 Sanding belt P60 / 3 pcs
 5997708107603 40x303 Sanding belt P80 / 3 pcs
 5997708107610 40x303 Sanding belt P100 / 3 pcs
 5997708107627 40x303 Sanding belt P120 / 3 pcs

5997708104527 60x400 Sanding belt P40 / 3 pcs
 5997708101076 60x400 Sanding belt P60 / 3 pcs
 5997708101083 60x400 Sanding belt P80 / 3 pcs
 5997708101090 60x400 Sanding belt P100 / 3 pcs
 5997708104534 60x400 Sanding belt P120 / 3 pcs

5997708104541 65x410 Sanding belt P40 / 3 pcs
 5997708101106 65x410 Sanding belt P60 / 3 pcs
 5997708101113 65x410 Sanding belt P80 / 3 pcs
 5997708101120 65x410 Sanding belt P100 / 3 pcs
 5997708104558 65x410 Sanding belt P120 / 3 pcs

5997708104565 75x457 Sanding belt P40 / 3 pcs
 5997708101137 75x457 Sanding belt P60 / 3 pcs
 5997708101144 75x457 Sanding belt P80 / 3 pcs
 5997708101151 75x457 Sanding belt P100 / 3 pcs
 5997708104572 75x457 Sanding belt P120 / 3 pcs

5997708104589 75x510 Sanding belt P40 / 3 pcs
 5997708101168 75x510 Sanding belt P60 / 3 pcs
 5997708101175 75x510 Sanding belt P80 / 3 pcs
 5997708101182 75x510 Sanding belt P100 / 3 pcs
 5997708104596 75x510 Sanding belt P120 / 3 pcs

5997708104602 75x533 Sanding belt P40 / 3 pcs
 5997708101199 75x533 Sanding belt P60 / 3 pcs
 5997708101205 75x533 Sanding belt P80 / 3 pcs
 5997708101212 75x533 Sanding belt P100 / 3 pcs
 5997708104619 75x533 Sanding belt P120 / 3 pcs

5997708109294 40x303 Sanding belt, mixed / 3 pcs
 5997708109300 60x400 Sanding belt, mixed / 3 pcs
 5997708109317 65x410 Sanding belt, mixed / 3 pcs
 5997708109324 75x457 Sanding belt, mixed / 3 pcs
 5997708109331 75x510 Sanding belt, mixed / 3 pcs
 5997708109348 75x533 Sanding belt, mixed / 3 pcs

5997708105678 100x552 Sanding belt P40 / 3 pcs
 5997708101229 100x552 Sanding belt P60 / 3 pcs
 5997708101236 100x552 Sanding belt P80 / 3 pcs
 5997708101243 100x552 Sanding belt P100 / 3 pcs
 5997708105685 100x552 Sanding belt P120 / 3 pcs

5997708105692 100x560 Sanding belt P40 / 3 pcs
 5997708101250 100x560 Sanding belt P60 / 3 pcs
 5997708101267 100x560 Sanding belt P80 / 3 pcs
 5997708101274 100x560 Sanding belt P100 / 3 pcs
 5997708105708 100x560 Sanding belt P120 / 3 pcs

5997708105715 100x610 Sanding belt P40 / 3 pcs
 5997708101281 100x610 Sanding belt P60 / 3 pcs
 5997708101298 100x610 Sanding belt P80 / 3 pcs
 5997708101304 100x610 Sanding belt P100 / 3 pcs
 5997708105722 100x610 Sanding belt P120 / 3 pcs

5997708105739 100x620 Sanding belt P40 / 3 pcs
 5997708101311 100x620 Sanding belt P60 / 3 pcs
 5997708101328 100x620 Sanding belt P80 / 3 pcs
 5997708101335 100x620 Sanding belt P100 / 3 pcs
 5997708105746 100x620 Sanding belt P120 / 3 pcs



Hp META

Sanding Belts
Schleifbänder
Bandes Abrasives
Csiszolószalag

Méret	Szemcsefinomság				
	40	60	80	100	120
60x400					
65x410					
75x457		●			
75x510					
75x533					

Megmunkálható anyagok:

Hp META

Sanding Belts
Schleifbänder
Bandes Abrasives
Csiszolószalag

Méret	Szemcsefinomság				
	40	60	80	100	120
400					
410		●			
457					
510					
533					

Megmunkálható anyagok:

Sand papers, abrasive clothes



Abrasive papers and waterproof sandpaper and cloth

5997708104787 A4 Sand paper P60 / 10 pcs
 5997708104794 A4 Sand paper P80 / 10 pcs
 5997708104800 A4 Sand paper P100 / 10 pcs
 5997708109263 A4 Sand paper, mixed / 10 pcs

5997708105517 A4 Abrasive cloth P60 / 10 pcs
 5997708105524 A4 Abrasive cloth P80 / 10 pcs
 5997708105531 A4 Abrasive cloth P100 / 10 pcs
 5997708109270 A4 Abrasive cloth, mixed / 10 pcs

5997708105548 A4 Waterproof Sand paper P400 / 10 pcs
 5997708105555 A4 Waterproof Sand paper P600 / 10 pcs
 5997708105562 A4 Waterproof Sand paper P800 / 10 pcs
 5997708109287 A4 Waterproof Sand paper, mixed / 10 pcs

5997708111037 A4 Sand paper P30
 5997708111047 A4 Sand paper P36
 5997708101014 A4 Sand paper P40
 5997708110993 A4 Sand paper P50
 5997708110994 A4 Sand paper P60
 5997708111006 A4 Sand paper P70
 5997708101021 A4 Sand paper P80
 5997708101038 A4 Sand paper P100
 5997708100628 A4 Sand paper P120
 5997708111013 A4 Sand paper P150
 5997708111020 A4 Sand paper P180

5997708111054 A4 Abrasive cloth P30
 5997708111068 A4 Abrasive cloth P36
 5997708101045 A4 Abrasive cloth P40
 5997708111075 A4 Abrasive cloth P50
 5997708101052 A4 Abrasive cloth P60
 5997708111082 A4 Abrasive cloth P70
 5997708101069 A4 Abrasive cloth P80
 5997708100635 A4 Abrasive cloth P100
 5997708100642 A4 Abrasive cloth P120
 5997708111099 A4 Abrasive cloth P150
 5997708111105 A4 Abrasive cloth P180

5997708111112 A3 Sand paper P30
 5997708111129 A3 Sand paper P36
 5997708110689 A3 Sand paper P40
 5997708111136 A3 Sand paper P50
 5997708110696 A3 Sand paper P60
 5997708111143 A3 Sand paper P70
 5997708110702 A3 Sand paper P80
 5997708110719 A3 Sand paper P100
 5997708110726 A3 Sand paper P120
 5997708111150 A3 Sand paper P150
 5997708111167 A3 Sand paper P180

5997708111174 A3 Abrasive cloth P30
 5997708111181 A3 Abrasive cloth P36
 5997708110733 A3 Abrasive cloth P40
 5997708111198 A3 Abrasive cloth P50
 5997708110740 A3 Abrasive cloth P60
 5997708111204 A3 Abrasive cloth P70
 5997708110757 A3 Abrasive cloth P80
 5997708110764 A3 Abrasive cloth P100
 5997708110771 A3 Abrasive cloth P120
 5997708111211 A3 Abrasive cloth P150
 5997708111228 A3 Abrasive cloth P180

Sand papers, abrasive clothes

5997708102844 A4 Waterproof sand paper P320
 5997708102851 A4 Waterproof sand paper P400
 5997708102868 A4 Waterproof sand paper P600
 5997708102875 A4 Waterproof sand paper P800
 5997708102882 A4 Waterproof sand paper P1000

Abrasive papers for vibration grinder

5997708105579 93x230 Sand paper P40 / 10 pcs
 5997708105586 93x230 Sand paper P60 / 10 pcs
 5997708105593 93x230 Sand paper P80 / 10 pcs
 5997708105609 93x230 Sand paper P100 / 10 pcs
 5997708105616 93x230 Sand paper P120 / 10 pcs
 5997708109386 93x230 Sand paper, mixed / 10 pcs

5997708107139 93x230 Sand paper P40 / 10 pcs / L
 5997708107146 93x230 Sand paper P60 / 10 pcs / L
 5997708107153 93x230 Sand paper P80 / 10 pcs / L
 5997708107160 93x230 Sand paper P100 / 10 pcs / L
 5997708107177 93x230 Sand paper P120 / 10 pcs / L
 5997708109393 93x230 Sand paper, mixed / 10 pcs / L

5997708105623 115x280 Sand paper P40 / 10 pcs
 5997708105630 115x280 Sand paper P60 / 10 pcs
 5997708105647 115x280 Sand paper P80 / 10 pcs
 5997708105654 115x280 Sand paper P100 / 10 pcs
 5997708105661 115x280 Sand paper P120 / 10 pcs
 5997708109409 115x280 Sand paper, mixed / 10 pcs

5997708107184 115x280 Sand paper P40 / 10 pcs / L
 5997708107191 115x280 Sand paper P60 / 10 pcs / L
 5997708107207 115x280 Sand paper P80 / 10 pcs / L
 5997708107214 115x280 Sand paper P100 / 10 pcs / L
 5997708107221 115x280 Sand paper P120 / 10 pcs / L
 5997708109416 115x280 Sand paper, mixed / 10 pcs / L

5997708104923 93x230 Sand paper P60 / 30 pcs
 5997708104930 93x230 Sand paper P80 / 30 pcs
 5997708104947 93x230 Sand paper P100 / 30 pcs
 5997708109423 93x230 Sand paper, mixed / 30 pcs

5997708104978 115x280 Sand paper P60 / 30 pcs
 5997708104985 115x280 Sand paper P80 / 30 pcs
 5997708104992 115x280 Sand paper P100 / 30 pcs
 5997708109430 115x280 Sand paper, mixed / 30 pcs

5997708104916 93x230 Sand paper P40 / 30 pcs / L
 5997708107238 93x230 Sand paper P60 / 30 pcs / L
 5997708107245 93x230 Sand paper P80 / 30 pcs / L
 5997708107252 93x230 Sand paper P100 / 30 pcs / L
 5997708104954 93x230 Sand paper P120 / 30 pcs / L
 5997708109447 93x230 Sand paper, mixed / 30 pcs / L

5997708104961 115x280 Sand paper P40 / 30 pcs / L
 5997708107269 115x280 Sand paper P60 / 30 pcs / L
 5997708107276 115x280 Sand paper P80 / 30 pcs / L
 5997708107283 115x280 Sand paper P100 / 30 pcs / L
 5997708105005 115x280 Sand paper P120 / 30 pcs / L
 5997708109454 115x280 Sand paper, mixed / 30 pcs / L

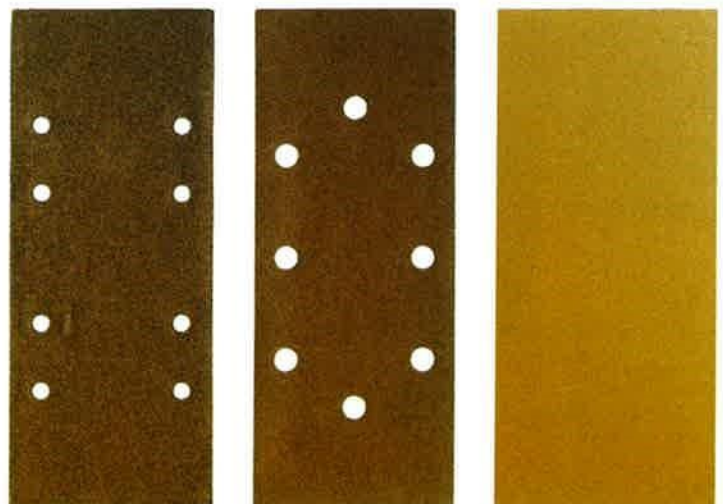

Cut-off and grinding wheels

Cut-off wheel

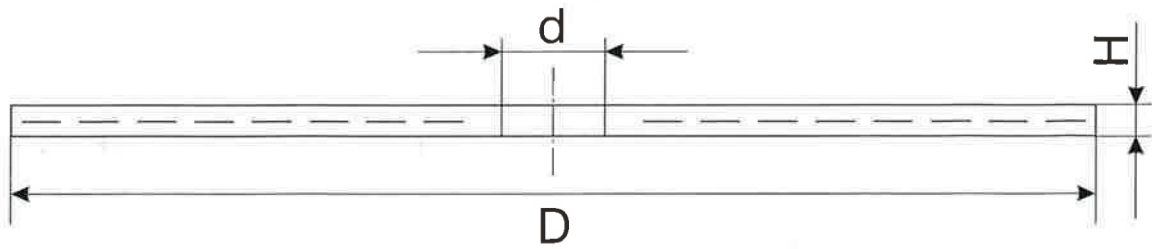

- 5997708100666 Ø 115x3,2x22,2 Cut-off wheel for metal / DIY
- 5997708123009 Ø 115x1x22,2 Cut-off wheel for metal
- 5997708123016 Ø 115x1,6x22,2 Cut-off wheel for metal
- 5997708109515 Ø 115x2,5x22,2 Cut-off wheel for metal
- 5997708110887 Ø 115x3,2x22,2 Cut-off wheel for metal
- 5997708100673 Ø 125x3,2x22,2 Cut-off wheel for metal
- 5997708100680 Ø 150x3,2x22,2 Cut-off wheel for metal
- 5997708100697 Ø 180x3,2x22,2 Cut-off wheel for metal
- 5997708100840 Ø 230x3,2x22,2 Cut-off wheel for metal / DIY
- 5997708109539 Ø 230x3,2x22,2 Cut-off wheel for metal
- 5997708100970 Ø 300x3,2x22,2 Cut-off wheel for metal
- 5997708100987 Ø 400x4x40 Cut-off wheel for metal

DIY = Do it yourself Quality
 Size: D × H × d
 Grain: 1A, 6A, 1C
 Grain size: 20, 24, 30, 36, 46, 54, 60
 Grinding wheel grade: N, O, P, Q, R, S, T
 Structure number: 5, 6, 7, 8
 Bond: BF



Cut-off and grinding wheels

- 5997708102134 Ø 115x3,2x22,2 Cut-off wheel for stone / DIY
 5997708109522 Ø 115x2,5x22,2 Cut-off wheel for stone
 5997708102677 Ø 125x3,2x22,2 Cut-off wheel for stone
 5997708103216 Ø 150x3,2x22,2 Cut-off wheel for stone
 5997708100710 Ø 180x3,2x22,2 Cut-off wheel for stone
 5997708102141 Ø 230x3,2x22,2 Cut-off wheel for stone / DIY
 5997708109546 Ø 230x3,2x22,2 Cut-off wheel for stone
- 5997708100963 Ø 115x3,2x22,2 Cut-off wheel for stainless steel
- 5997708104718 Ø 115x2,5x22,2 Cut-off wheel for metal / 5 pcs / DIY
 5997708104725 Ø 115x2,5x22,2 Cut-off wheel for stone / 5 pcs / DIY
 5997708104732 Ø 180x2,5x22,2 Cut-off wheel for metal / 5 pcs / DIY
 5997708104749 Ø 180x2,5x22,2 Cut-off wheel for stone / 5 pcs / DIY
 5997708105456 Ø 230x3x22,2 Cut-off wheel for metal / 5 pcs / DIY
 5997708105463 Ø 230x3x22,2 Cut-off wheel for stone / 5 pcs / DIY

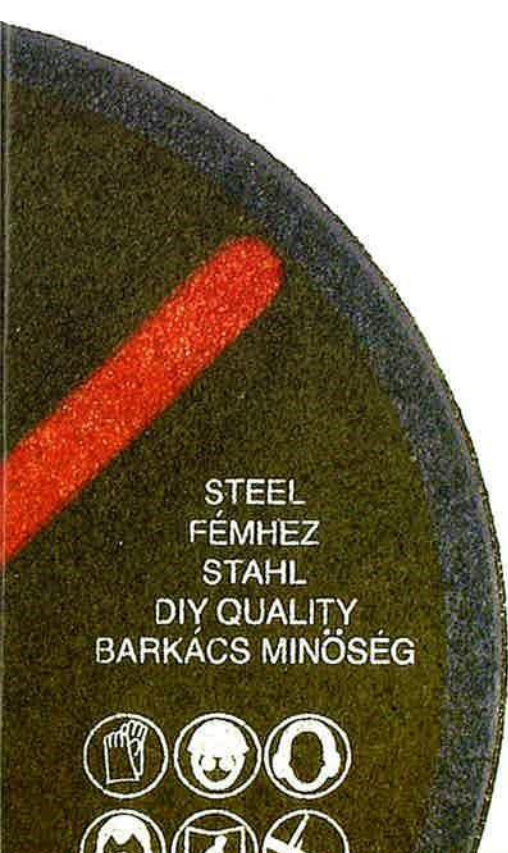

Cut-off and grinding wheels

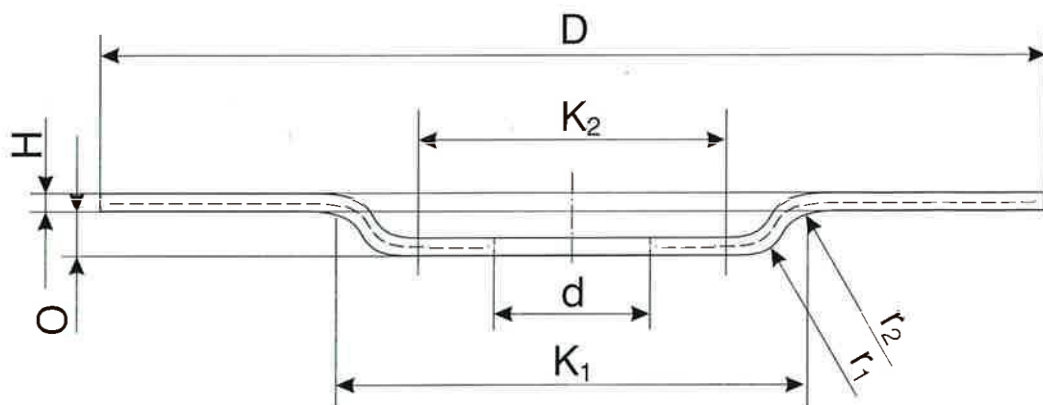

STONE
KÖHÖZ
STEIN



M
META

SIZES
MÉRET
ABMESSUNGEN
180 x 6 x 22,2
1 A 30 R8 BF+
80 m/s
MAX. R.P.M.
8.600/min
MSZ 4554/3

Cut-off and grinding wheels

Grinding wheel

5997708102158 Ø 115x4x22,2 Grinding wheel for metal
 5997708102165 Ø 115x6x22,2 Grinding wheel for metal
 5997708103209 Ø 125x4x22,2 Grinding wheel for metal
 5997708103261 Ø 125x6x22,2 Grinding wheel for metal
 5997708103292 Ø 180x6x22,2 Grinding wheel for metal

5997708102387 Ø 115x6x22,2 Grinding wheel for stone
 5997708103278 Ø 125x6x22,2 Grinding wheel for stone
 5997708103285 Ø 180x6x22,2 Grinding wheel for stone

5997708102400 Ø 115x4x22,2 Grinding wheel for stainless steel

5990810104756 Ø 115x4x22,2 Grinding wheel for metal / 5 pcs

Size: D × H × d

Grain: 1A, 6A, 1C

Grain size: 24, 30, 36, 46, 54

Grinding wheel grade: O, P, Q, R, S

Structure number: 5, 6, 7, 8

Bond: BF



Cut-off and grinding wheels

Diamond cutting wheels for angle grinder

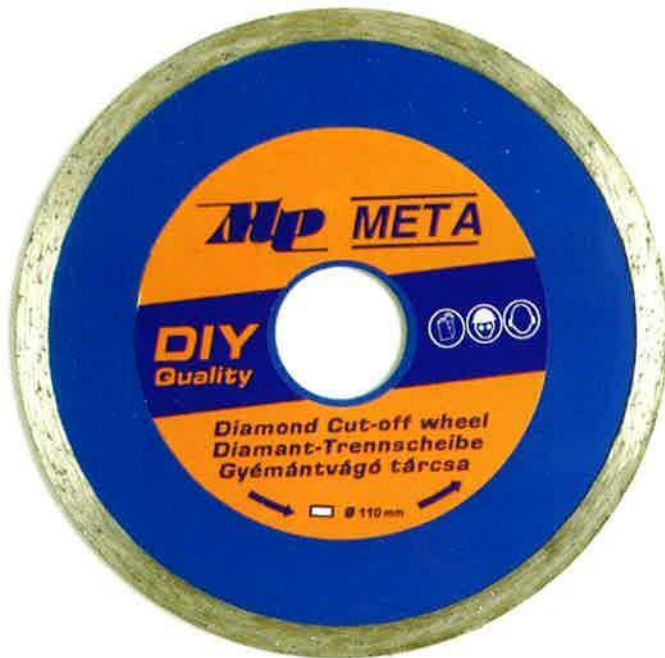

- 5997708102516 Ø 110 Diamond cutting wheel, tile
- 5997708102653 Ø 115 Diamond cutting wheel, concrete, floortile
- 5997708102660 Ø 230 Diamond cutting wheel, concrete, floortile

- Diamond cutting wheel for deskmachine
- 4022202144128 Ø 150 Diamond cutting wheel, tile
 - 5997708110238 Ø 150x20 Diamond cutting wheel, tile
 - 5997708105890 Ø 180 Diamond cutting wheel, concrete, floortile
 - 5997708106637 Ø 180 Diamond cutting wheel, tile
 - 5997708110245 Ø 180x25 Diamond cutting wheel, tile
 - 5997708110351 Ø 200 Diamond cutting wheel, tile
 - 5997708110252 Ø 200x25 Diamond cutting wheel, tile
 - 5997708110313 Ø 200x30 Diamond cutting wheel, concrete, marble (SK25)
 - 5997708110320 Ø 230x30 Diamond cutting wheel, concrete, marble (SK25)
 - 5997708110337 Ø 250x30 Diamond cutting wheel, concrete, marble (SK25)
 - 5997708110344 Ø 300x30 Diamond cutting wheel, concrete, marble (SK25)

- Diamond cutting wheel for Fuguecutter
- 5997708105906 300x20/7 Diamond cutting wheel, asphalt (LA81)
 - 5997708105913 300x20/15 Diamond cutting wheel, asphalt (LA83)
 - 5997708105920 300x20/35 Diamond cutting wheel, asphalt (LA87)
 - 5997708105937 350x20/7 Diamond cutting wheel, asphalt (LA81)
 - 5997708105944 350x1"/20//15 Diamond cutting wheel, asphalt (LA83)
 - 5997708105951 350x1"/20//35 Diamond cutting wheel, asphalt (LA87)

- 5997708105968 400x1"/20/7 Diamond cutting wheel, asphalt (LA81)
- 5997708105975 400x1"/20//15 Diamond cutting wheel, asphalt (LA83)
- 5997708105982 400x1"/20//35 Diamond cutting wheel, asphalt (LA87)
- 5997708105999 450x1"/20//15 Diamond cutting wheel, asphalt (LA83)
- 5997708106002 450x1"/20//35 Diamond cutting wheel, asphalt (LA87)

- 5997708106019 300x20/7 Diamond cutting wheel, concrete (LB52)
- 5997708106026 300x20/15 Diamond cutting wheel, concrete (LB55)
- 5997708106033 300x20/35 Diamond cutting wheel, concrete (LB65)
- 5997708106040 350x20/7 Diamond cutting wheel, concrete (LB52)
- 5997708106057 350x1"/20//15 Diamond cutting wheel, concrete (LB55)
- 5997708106064 350x1"/20//35 Diamond cutting wheel, concrete (LB65)

- 5997708106071 400x1"/20/7 Diamond cutting wheel, concrete (LB52)
- 5997708106088 400x1"/20//15 Diamond cutting wheel, concrete (LB55)
- 5997708106095 400x1"/20//35 Diamond cutting wheel, concrete (LB65)
- 5997708106101 450x1"/20//15 Diamond cutting wheel, concrete (LB55)
- 5997708106118 450x1"/20//35 Diamond cutting wheel, concrete (LB65)
- 5997708105227 Diamondrope

- Diamond cutting wheel / DIY Qualität for angle grinder
- 5997708105388 Ø 110 Diamond cutting wheel, tile / DIY
 - 5997708105395 Ø 115 Diamond cutting wheel, concrete / DIY
 - 5997708105401 Ø 230 Diamond cutting wheel, concrete / DIY
 - 5997708109966 Ø 115 Diamond cutting wheel, concrete / 5 pcs / DIY
 - 5997708110429 Diamond cutting wheel, Ø115, Ø110, Ø230 / DIY



Marking: 300x20/7 300 Diameter, 20 Hole diameter,
7 Power of machine;
350x1"/20//15 350 Diameter, 1"/20 Hole diameter,
15 Power of machine.

Cut-off and grinding wheels



Saws

Fret saw



- 5997708103414 BS Fret saw for metal / 6 pcs
- 5997708103421 BD Fret saw for metal / 6 pcs
- 5997708103445 BS Fret saw for wood / 6 pcs
- 5997708103452 BD Fret saw for wood / 6 pcs

- 5997708121029 BS Fret saw for metal and wood / 10 pcs (A)
- 5997708121036 BD Fret saw for metal and wood / 10 pcs (C)
- 5997708121043 BS Fret saw for metal and wood / 10 pcs (B)

- 5997708121821 BS Fret saw for metal / Dentation 55/1/1 / 2 pcs
- 5997708121838 BS Fret saw for metal / Dentation 55/2/2 / 2 pcs
- 5997708121845 BS Fret saw for metal / Dentation 55/2/3 / 2 pcs
- 5997708121852 BS Fret saw for metal / Dentation 78/2/3 / 2 pcs
- 5997708121869 BS Fret saw for metal / Dentation 78/3/4 / 2 pcs
- 5997708121876 BS Fret saw for metal / Dentation 78/3/2,5 / 2 pcs
- 5997708121883 BD Fret saw for metal / Dentation 78/2/2 / 2 pcs
- 5997708121890 BD Fret saw for metal / Dentation 78/2/2,5 / 2 pcs
- 5997708121906 BD Fret saw for metal / Dentation 78/2/3 / 2 pcs
- 5997708121913 BD Fret saw for wood / Dentation 78/2/2 / 2 pcs
- 5997708121920 BD Fret saw for wood / Dentation 78/2/3 / 2 pcs
- 5997708121937 BD Fret saw for wood / Dentation 78/1/1 / 2 pcs
- 5997708121944 BD Fret saw for wood / Dentation 78/2/4 / 2 pcs
- 5997708121951 BS Fret saw for wood / Dentation 78/3/3 / 2 pcs
- 5997708121968 BS Fret saw for wood / Dentation 78/2/3 / 2 pcs
- 5997708121975 BS Fret saw for wood / Dentation 78/5/4 / 2 pcs
- 5997708121982 BS Fret saw for wood / Dentation 78/6/4 / 2 pcs
- 5997708121999 BD Fret saw for wood / Dentation 45/4/3 / 2 pcs

- 5997708122002 Long fret saw 200/180
- 5997708122019 Long fret saw 105/83
- 5997708122026 Long fret saw 155/133
- 5997708122033 Long fret saw 205/183
- 5997708122040 Long fret saw 255/233
- 5997708122057 Long fret saw 305/283

- 5997708122064 BS Fret saw, mixed / 3, 15 / 2 pcs
- 5997708122071 BD Fret saw, mixed / 8, 11 / 2 pcs
- 5997708122088 BS Fret saw, mixed / 2, 14 / 2 pcs
- 5997708122095 BS Fret saw, mixed / 5, 17 / 2 pcs
- 5997708122101 BS Fret saw, mixed / 4, 5 / 2 pcs
- 5997708122118 BS Fret saw, mixed / 15, 18 / 2 pcs

Marking
 BS = Bosch Machines
 BD = Black and Decker Machines

Saw belt

- 5997708111419 Saw belt for wood / 1079x4x0,4

We can produce this product in a wished size and quality.



Hole saw

5997708121388	Ø 19	Hole saw
5997708121395	Ø 20	Hole saw
5997708121401	Ø 22	Hole saw
5997708121418	Ø 24	Hole saw
5997708121425	Ø 25	Hole saw
5997708121432	Ø 28	Hole saw
5997708121449	Ø 30	Hole saw
5997708121456	Ø 32	Hole saw
5997708121463	Ø 35	Hole saw
5997708121470	Ø 38	Hole saw
5997708121487	Ø 40	Hole saw
5997708121494	Ø 43	Hole saw
5997708121500	Ø 46	Hole saw
5997708121517	Ø 48	Hole saw
5997708121524	Ø 51	Hole saw
5997708121531	Ø 54	Hole saw
5997708121548	Ø 57	Hole saw
5997708121555	Ø 60	Hole saw
5997708121562	Ø 64	Hole saw
5997708121579	Ø 68	Hole saw
5997708121586	Ø 70	Hole saw
5997708121593	Ø 73	Hole saw
5997708121609	Ø 76	Hole saw
5997708121616	Ø 79	Hole saw
5997708121623	Ø 83	Hole saw
5997708121630	Ø 86	Hole saw
5997708121647	Ø 89	Hole saw
5997708121654	Ø 92	Hole saw
5997708121661	Ø 95	Hole saw
5997708121678	Ø 98	Hole saw
5997708121685	Ø 102	Hole saw
5997708121692	Ø 105	Hole saw
5997708121708	Ø 108	Hole saw
5997708121715	Ø 111	Hole saw
5997708121722	Ø 114	Hole saw
5997708121739	Ø 121	Hole saw
5997708121746	Ø 127	Hole saw
5997708121753	Ø 133	Hole saw
5997708121760	Ø 140	Hole saw
5997708121777	Ø 146	Hole saw
5997708121784	Ø 152	Hole saw
5997708121791	Ø 165	Hole saw
5997708121807	Ø 178	Hole saw

5997708121814 Adapter for hole saw
 5997708123023 Universal hole saw for do it yourself

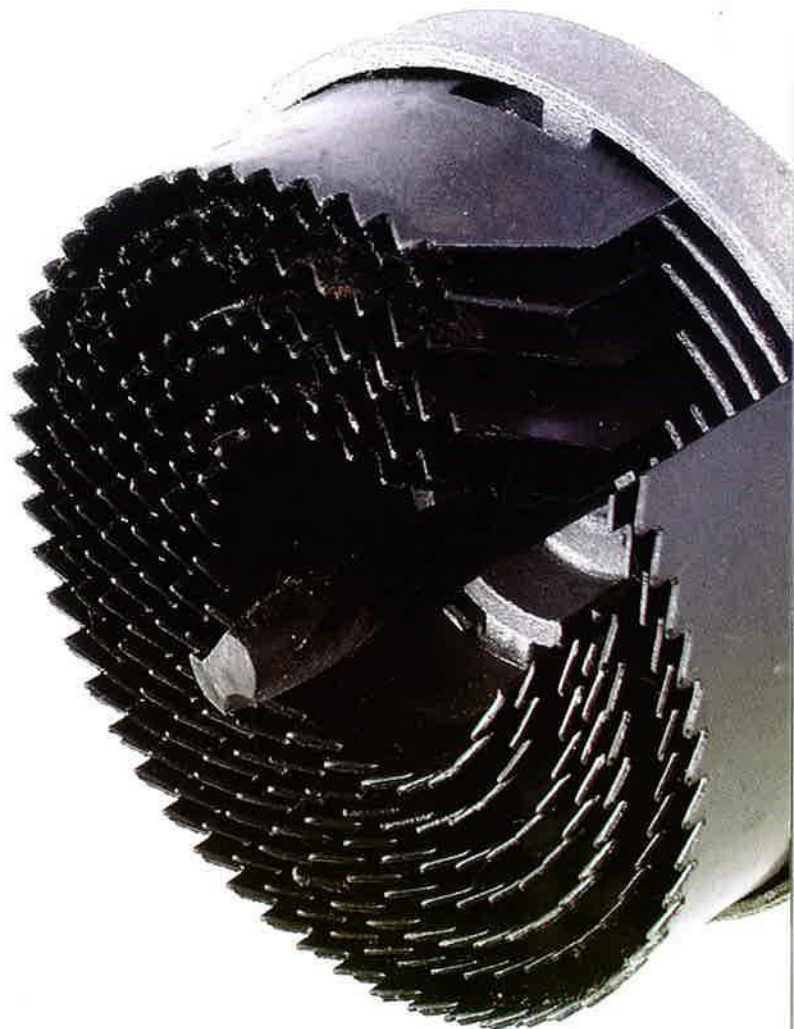

Circular saw / CRV3



(Nt = Nr. of teeth)

5997708103346 125x1,2x12,7 Circular saw A / Nt 24
 5997708104497 130x1,2x20 Circular saw A / Nt 24
 5997708103360 140x1,2x20 Circular saw A / Nt 24
 5997708103384 150x1,2x20 Circular saw A / Nt 30
 5997708102929 160x1,2x20 Circular saw A / Nt 32
 5997708102936 170x1,6x30 Circular saw A / Nt 36
 5997708102943 180x1,6x30 Circular saw A / Nt 42
 5997708103407 190x1,6x30 Circular saw A / Nt 42
 5997708103438 200x1,6x30 Circular saw A / Nt 42

5997708104404 125x1,2x12,7 Circular saw B / Nt 60
 5997708104411 130x1,2x20 Circular saw B / Nt 60
 5997708104428 140x1,2x20 Circular saw B / Nt 60
 5997708104435 150x1,2x20 Circular saw B / Nt 60
 5997708104442 160x1,2x20 Circular saw B / Nt 60
 5997708104459 170x1,6x30 Circular saw B / Nt 60
 5997708104466 180x1,6x30 Circular saw B / Nt 60
 5997708104473 190x1,6x30 Circular saw B / Nt 72
 5997708104480 200x1,6x30 Circular saw B / Nt 72

5997708104848 300x30 Circular saw B
 5997708104855 350x30 Circular saw B
 5997708104862 400x30 Circular saw B
 5997708104879 450x30 Circular saw B
 5997708104886 500x30 Circular saw B
 5997708104893 600x30 Circular saw B
 5997708104909 700x30 Circular saw B

A = Fein saw

B = Greb saw

Nt = Nr. of them

Circular saw / CRV3

Carbide-tipped circular saw

5997708102950 125x20 Carbide-tipped circular saw / Nt 10

5997708102967 125x20 Carbide-tipped circular saw / Nt 24

5997708103063 130x20 Carbide-tipped circular saw / Nt 10

5997708103070 130x20 Carbide-tipped circular saw / Nt 24

5997708103469 160x20 Carbide-tipped circular saw / Nt 12

5997708103476 160x20 Carbide-tipped circular saw / Nt 24

5997708103087 170x30 Carbide-tipped circular saw / Nt 12

5997708103094 170x30 Carbide-tipped circular saw / Nt 24

5997708103100 170x30 Carbide-tipped circular saw / Nt 52

5997708103483 180x30 Carbide-tipped circular saw / Nt 14

5997708103117 180x30 Carbide-tipped circular saw / Nt 24

5997708103124 180x30 Carbide-tipped circular saw / Nt 56

5997708104350 190x30 Carbide-tipped circular saw / Nt 14

5997708104367 190x30 Carbide-tipped circular saw / Nt 30

5997708104374 190x30 Carbide-tipped circular saw / Nt 56

5997708103506 200x30 Carbide-tipped circular saw / Nt 16

5997708104381 200x30 Carbide-tipped circular saw / Nt 36

5997708104398 200x30 Carbide-tipped circular saw / Nt 48

5997708105135 300x30 Carbide-tipped circular saw / Nt 28

5997708105142 300x30 Carbide-tipped circular saw / Nt 32

5997708105159 400x30 Carbide-tipped circular saw / Nt 24

5997708105166 400x30 Carbide-tipped circular saw / Nt 32

5997708105173 450x30 Carbide-tipped circular saw / Nt 36

5997708105180 500x30 Carbide-tipped circular saw / Nt 40

5997708105197 600x30 Carbide-tipped circular saw / Nt 40

5997708105203 700x30 Carbide-tipped circular saw / Nt 46

5997708110832 30/20 distance ring

5997708110849 30/16 distance ring

5997708110856 20/16 distance ring

5997708110863 20/12,7 distance ring

5997708110870 30/18 distance ring



Vitrified bonded grinding stones

Grinding stone

Quality: 1C 60M 5V 36

5997708104510 Ø 150x16x20 Grinding stone disc 1C
5997708100758 Ø 150x20x20 Grinding stone disc 1C
5997708100765 Ø 175x20x20 Grinding stone disc 1C
5997708100772 Ø 175x20x32 Grinding stone disc 1C
5997708104824 Ø 200x20x32 Grinding stone disc 1C
5997708102431 Ø 300x25x40 Grinding stone disc 1C

Quality: 6A 60M 8V 38

5997708103339 Ø 125x16x12,7 Grinding stone disc 6A
5997708103193 Ø 125x20x20 Grinding stone disc 6A
5997708104503 Ø 150x16x20 Grinding stone disc 6A
5997708100789 Ø 150x20x20 Grinding stone disc 6A
5997708100796 Ø 175x20x20 Grinding stone disc 6A
5997708100802 Ø 175x20x32 Grinding stone disc 6A
5997708104814 Ø 200x20x32 Grinding stone disc 6A
5997708102424 Ø 300x25x40 Grinding stone disc 6A

**We can produce grinding stones
in wishes size and quality.**

Grinding stones with special form

5997708100819 240x35x15 Wheelstone 1C
5997708100826 240x35x15 Wheelstone 6A

5997708100833 200x18 Truing tool

Vitrified bonded grinding stones

Pin stone

5997708101823 10x20x6 Pin stone, coned
 5997708101830 20x40x6 Pin stone, coned
 5997708101847 10x20x6 Pin stone
 5997708101854 20x40x6 Pin stone
 5997708101861 13x20x6 Pin stone
 5997708101878 16x25x6 Pin stone
 5997708101885 25x25x6 Pin stone

Professional pin stone:

5997708106125 16x50x6 Pin stone 7A / 4522/1
 5997708106132 20x20x6 Pin stone 1C / 4522/1
 5997708106149 20x25x6 Pin stone 7A / 4522/1
 5997708106156 25x25x6 Pin stone 1C / 4522/1
 5997708106163 32x10x6 Pin stone 6A / 4522/1
 5997708106170 32x10x6 Pin stone 7A / 4522/1
 5997708106187 32x32x6 Pin stone 1C / 4522/1
 5997708106194 40x20x6 Pin stone 7A / 4522/1
 5997708106200 40x20x6 Pin stone 1C / 4522/1
 5997708106217 40x40x6 Pin stone 6A / 4522/1
 5997708106224 50x16x6 Pin stone 16A / 4522/1
 5997708106231 50x20x6 Pin stone 1C / 4522/1
 5997708106248 20x25x6 Pin stone 6A / 4522/1
 5997708106255 20x25x6 Pin stone 7A / 4522/2
 5997708106262 13x20x6 Pin stone 6A / 4522/4
 5997708106279 13x20x6 Pin stone 7A / 4522/4
 5997708106286 20x25x6 Pin stone 6A / 4522/4
 5997708106293 20x25x6 Pin stone 7A / 4522/4
 5997708106309 25x20x6 Pin stone 6A / 4522/5
 5997708106316 25x20x6 Pin stone 7A / 4522/5
 5997708106323 19x63x6 Pin stone 6A / 4522/A1
 5997708106330 25x32x6 Pin stone 6A / 4522/A2
 5997708106347 22x70x6 Pin stone 7A / 4522/A3
 5997708106354 32x32x6 Pin stone 7A / 4522/A4
 5997708106361 19x29x6 Pin stone 6A / 4522/A5
 5997708106378 19x29x6 Pin stone 7A / 4522/A5
 5997708106385 19x29x6 Pin stone 7A / 4522/A6
 5997708106392 30x50x6 Pin stone 7A / 4522/A7
 5997708106408 30x50x6 Pin stone 7A / 4522/A9
 5997708106415 17x22x6 Pin stone 6A / 4522/A14
 5997708106422 17x22x6 Pin stone 7A / 4522/A14
 5997708106439 37x37x6 Pin stone 7A / 4522/A16
 5997708106446 37x37x6 Pin stone 7A / 4522/A18
 5997708106453 30x50x6 Pin stone 7A / 4522/A19
 5997708106460 25x25x6 Pin stone 7A / 4522/A21
 5997708106477 19x25x6 Pin stone 18A / 4522/A23
 5997708106484 20x6 Pin stone 7A / 4522/A40
 5997708106491 16x16x3 Pin stone 7A / 4522/B41
 5997708106507 6x8x3 Pin stone 7A / 4522/B43
 5997708106514 6x10x3 Pin stone 7A / 4522/B44
 5997708106521 11x20x3 Pin stone 7A / 4522/B51
 5997708106538 13x10x3 Pin stone 6A / 4522/B62
 5997708106545 13x6x3 Pin stone 6A / 4522/B82
 5997708106552 13x16x3 Pin stone 7A / 4522/B91
 5997708106569 8x10x3 Pin stone 7A / 4522/B104
 5997708106576 11x17x3 Pin stone 6A / 4522/B111
 5997708106583 10x3 Pin stone 6A / 4522/B122
 5997708106590 10x10x3 Pin stone 7A / 4522/1
 5997708106606 16x20x3 Pin stone 7A / 4522/1
 5997708106613 25x6x3 Pin stone 8A / 4522/1



Vitrified bonded grinding stones



Regular aluminium oxide: 1A
It is the general widely used alumina. The tools made of this material are suitable for processing low alloyed steels, superhard and middle hard metallic goods. It is very suitable for high cutting speed and rough processes.



Red aluminium oxide: 8A
Because of its high contents of chrom, it is very suitable for grinding of alloyed steels and tool steels.



White aluminium oxide: 6A
It is the most suitable grit for tool grinding. In addition to precision grinding and processing of high-speed steels, it is used to precision grinding of hardened and stainless-steels, too.



Black silicon carbide: 1C
It can be used for grinding of low tensile metallic and non-metallic materials, gray cast iron, bronze, aluminium, chill cast iron, malleable cast iron, copper as well as organic, mineral and ceramic goods.



Pink aluminium oxide: 7A
It is suitable to grind high tensile alloyed steels before hardening and for processing cast irons.



Green silicon carbide: 2C
First of all it is used for processing hard metal, ceramic materials, glass and acid-resistant austenitic steels.

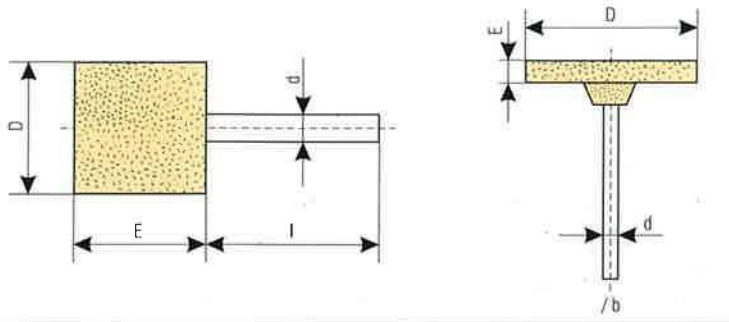

Cylindrical grinding tool with shaft

MSZ 4522/1-83
Dimension: $D \times E \times d$

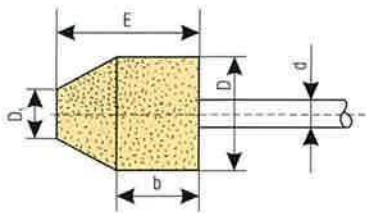

Cylindrical-conical grinding tool with shaft

Standard number: MSZ 4522/2-83
Dimension: $D \times E \times d$

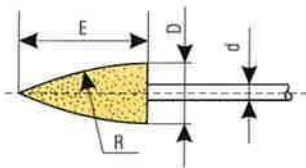

Cambered grinding tool with shaft

Standard number: MSZ 4522/3-83
Dimension: $D \times E \times d$

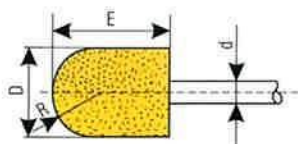

Cylindrical round-ended grinding tool with shaft

Standard number: MSZ 4522/4-83
Dimension: $D \times E \times d$

Vitrified bonded grinding stones

Flaring-Cup grinding tool with shaft

Standard number: MSZ 4522/5-83
Dimension: $D \times E \times d$

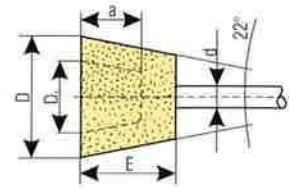

Spherical grinding tool with shaft

Standard number: MSZ 4522/6-83
Dimension: $D \times d$

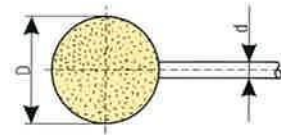

Steel shafts grinding tool with shaft

The shape and dimensions of the wheel shafts are determined by the wheel manufacturer in accordance with the safety regulations.
Types of ISO „A“ $d=6^h$ mm, $l=40$ mm.
Types of ISO „B“ $d=3^h$ mm, $l=30$ mm.

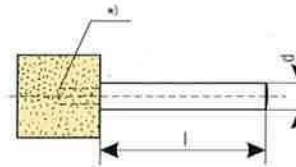

Grinding tool with shaft

Standard number: ISO 2933
A1–A19

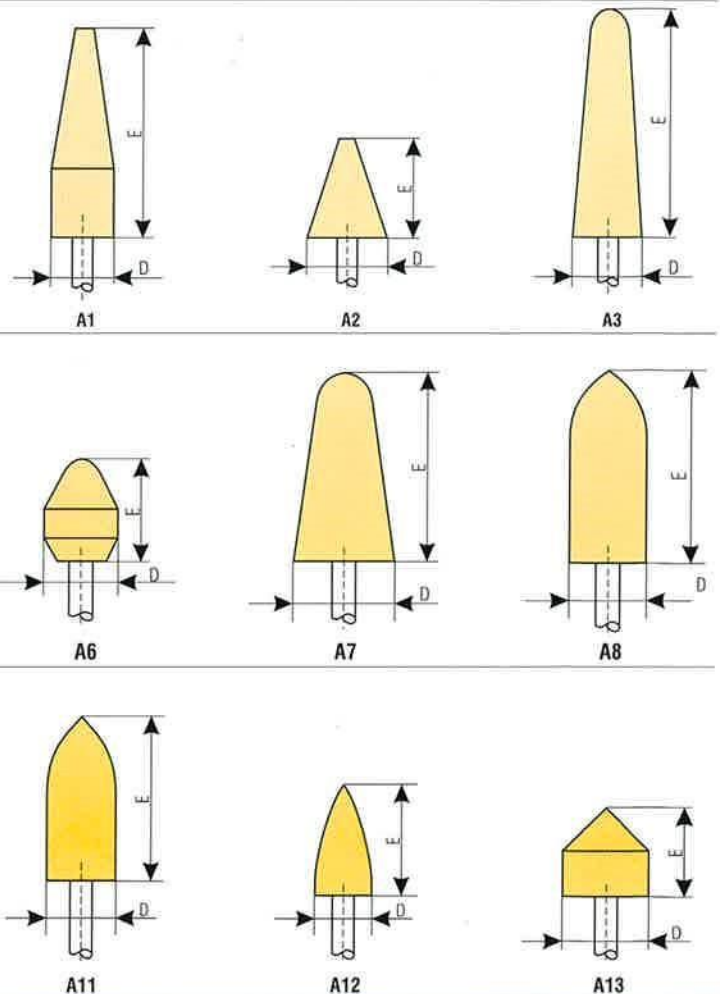

Vitrified bonded grinding stones

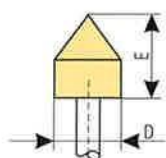

A14

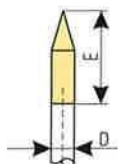

A15

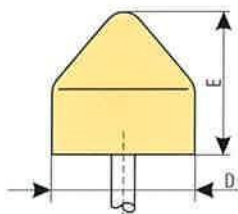

A16

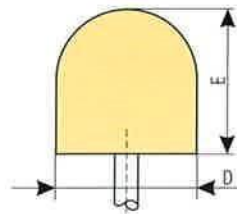

A18

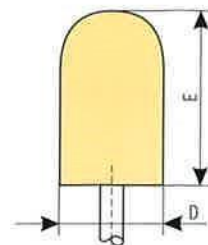

A19

Grinding tool with shaft

Standard number: ISO 2933
A20-A39

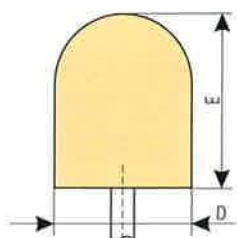

A20

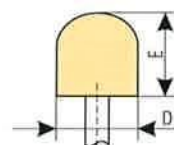

A21

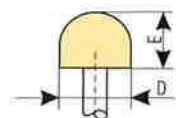

A22

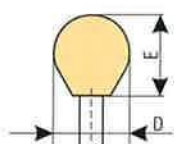

A23

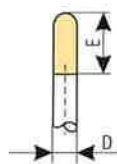

A24

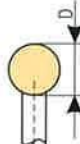

A26

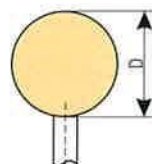

A27

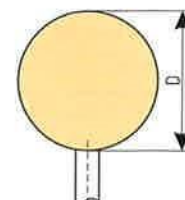

A28

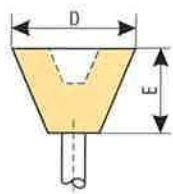

A31

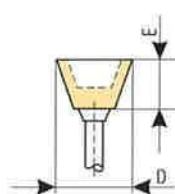

A32

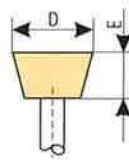

A33

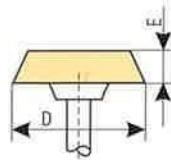

A34

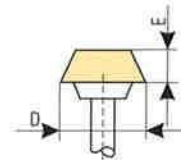

A35

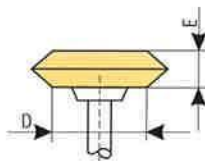

A36

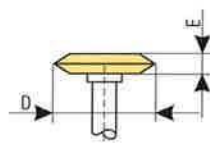

A37

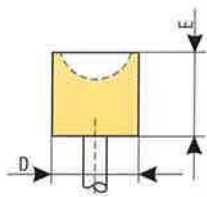

A38

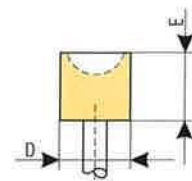

A39

Grinding tool with shaft

Standard number: ISO 2933
B41-B91

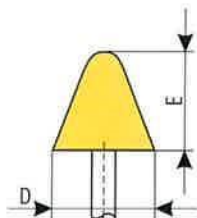

B41

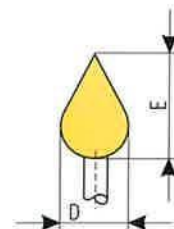

B42

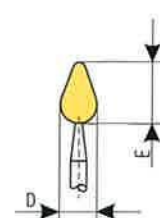

B44

Vitrified bonded grinding stones

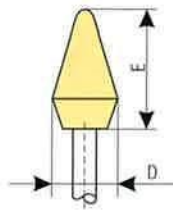

B51

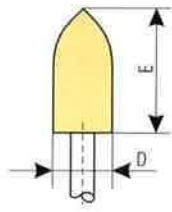

B52

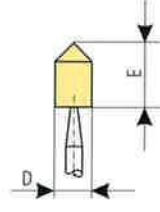

B54

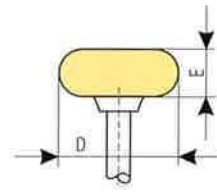

B61

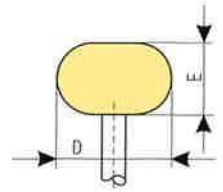

B62

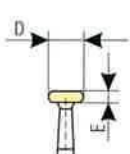

B64

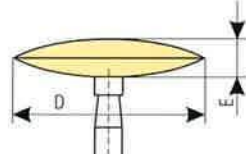

B70

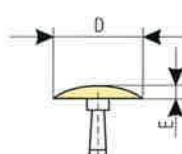

B71

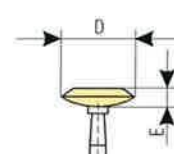

B72

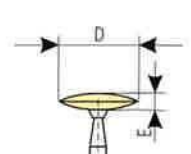

B73

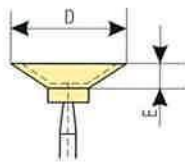

B81

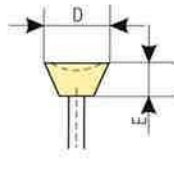

B82

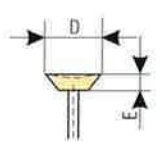

B83

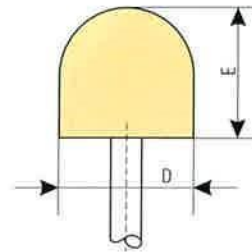

B90

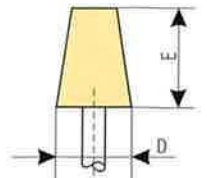

B91

Grinding tool with shaft

Standard number: ISO 2933
B92-B134

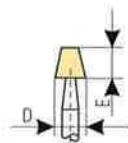

B92

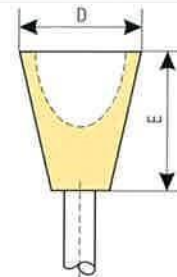

B101

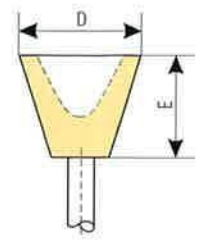

B102

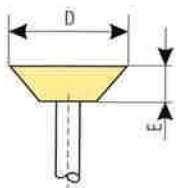

B103

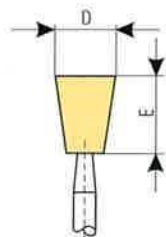

B104

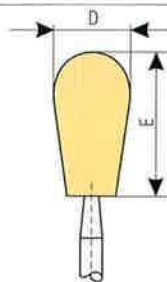

B111

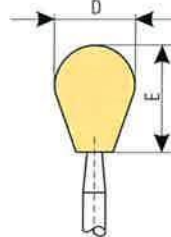

B112

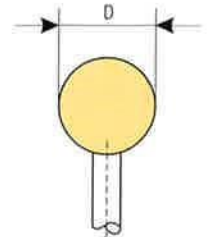

B121

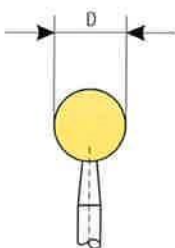

B122

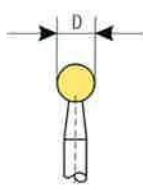

B123

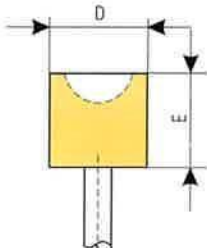

B131

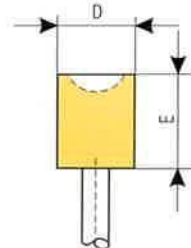

B132

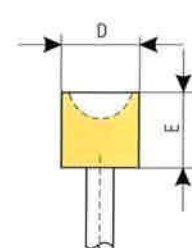

B133

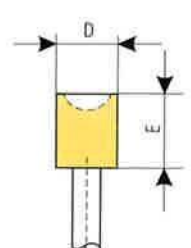

B134

Grinding discs



Grinding disc

- 5997708100017 Ø 105 Grinding disc for drilling machine
- 5997708100086 Ø 115 Flexible grinding disc for anglegrinder
- 5997708100277 Ø 125 Grinding disc for drilling machine
- 5997708100314 Ø 125 Grinding disc with flexible surface and velcro for anglegrinder
- 5997708107573 Grinding disc for drilling machine

Flap disc

- 5997708103148 Ø 115 Flap disc P100 / Metal disc
- 5997708103155 Ø 115 Flap disc P80 / Metal disc
- 5997708103162 Ø 115 Flap disc P60 / Metal disc
- 5997708101717 Ø 115 Flap disc P40 / Metal disc
- 5997708100468 Ø 115 Flap disc P100 / Plastic disc
- 5997708100475 Ø 115 Flap disc P80 / Plastic disc
- 5997708100482 Ø 115 Flap disc P60 / Plastic disc
- 5997708103179 Ø 115 Flap disc P40 / Plastic disc
- 5997708100499 Ø 180 Flap disc P80 / Metal disc
- 5997708100505 Ø 180 Flap disc P60 / Metal disc
- 5997708100512 Ø 180 Flap disc P40 / Metal disc

We can produce this product for special works
(for only metal or wood).



Fibre disc

5997708102219 Ø 115 Rubberplate
5997708102226 Ø 180 Rubberplate

5997708102585 Ø 115 Fibre disc for metal P40 / DIY
5997708102233 Ø 115 Fibre disc for metal P60 / DIY
5997708102240 Ø 115 Fibre disc for metal P80 / DIY

5997708102592 Ø 180 Fibre disc for metal P40 / DIY
5997708102257 Ø 180 Fibre disc for metal P60 / DIY
5997708102264 Ø 180 Fibre disc for metal P80 / DIY

5997708105753 Ø 115 Professional fibre disc for metal P24
5997708105760 Ø 115 Professional fibre disc for metal P36
5997708105784 Ø 115 Professional fibre disc for metal P60
5997708105791 Ø 115 Professional fibre disc for metal P80

5997708105807 Ø 180 Professional fibre disc for metal P24
5997708105814 Ø 180 Professional fibre disc for metal P36
5997708105838 Ø 180 Professional fibre disc for metal P60
5997708105845 Ø 180 Professional fibre disc for metal P80

5997708105852 Ø 115 Fibre disc for stone P24
5997708105869 Ø 115 Fibre disc for stone P36
5997708102608 Ø 115 Fibre disc for stone P60
5997708102615 Ø 115 Fibre disc for stone P80

5997708105876 Ø 180 Fibre disc for stone P24
5997708105883 Ø 180 Fibre disc for stone P36
5997708102639 Ø 180 Fibre disc for stone P60
5997708102646 Ø 180 Fibre disc for stone P80

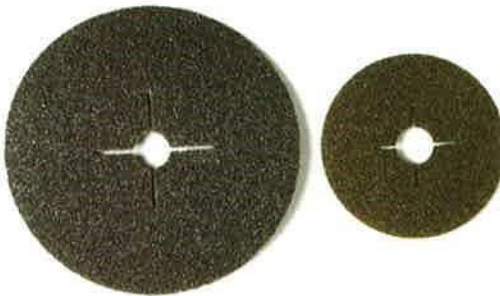

Polishing disc

5997708100376 Ø 125 Polishing disc with velcro, synthetic
5997708100390 Ø 125 Polishing disc with velcro, sponge
5997708100079 Ø 115 Self-adhesive polishing disc, synthetic
5997708106699 Ø 115 Self-adhesive polishing disc, synthetic / 10 pcs

5997708107108 96 self-adhesive triangle polishing disc, felt
5997708107115 105 self-adhesive triangle polishing disc, felt
5997708107122 107 self-adhesive triangle polishing disc, felt



Steel brushes, steel wire wheels

Wirebrush

- 5997708105029 Handbrush from Brass
 5997708105036 Instrument brush from steel
 5997708105104 Wirebrush from steel
 5997708105111 Wirebrush from Brass

Steel wire wheel

- 5997708101458 Ø 80 Steel wire wheel
 5997708101380 Ø 100 Steel wire wheel
 5997708101397 Potbrush
 5997708101410 Ø 115 Steel wire wheel
 5997708101427 Ø 180 Steel wire wheel
 5997708109935 Ø 80 Steel wire wheel /without packing/
 5997708109942 Ø 100 Steel wire wheel /without packing/
 5997708109959 Potbrush /without packing/
 5997708105050 Ø 200 Round steel brush
 5997708105067 Ø 250 Round steel brush
 5997708105074 Ø 300 Round steel brush
 5997708105081 Ø 350 Round steel brush
 5997708104336 Ø 115 Roped steel wire wheel / flexible
 5997708104343 Steel wire, roped for pot / flexible / M14
 5997708105012 Roped coned steel brush / flexible / M14



Bit for drillmachine

- 5997708121050 PZ1 bit for drillmachine (DIN 3126/C6,3/25mm)/2 pcs
- 5997708121067 PZ2 bit for drillmachine (DIN 3126/C6,3/25mm)/2 pcs
- 5997708121074 PZ3 bit for drillmachine (DIN 3126/C6,3/25mm)/2 pcs
- 5997708121081 PZ4 bit for drillmachine (DIN 3126/C6,3/25mm)/2 pcs

- 5997708121098 PH1 bit for drillmachine (DIN 3126/C6,3/25mm)/2 pcs
- 5997708121104 PH2 bit for drillmachine (DIN 3126/C6,3/25mm)/2 pcs
- 5997708121111 PH3 bit for drillmachine (DIN 3126/C6,3/25mm)/2 pcs
- 5997708121128 PH1-3 bit for drillmachine (DIN 3126/C6,3/25mm)/3 pcs

- 5997708121135 PH1 bit for drillmachine (DIN 3126/E6,3/50mm)/2 pcs
- 5997708121142 PH2 bit for drillmachine (DIN 3126/E6,3/50mm)/2 pcs
- 5997708121159 PH3 bit for drillmachine (DIN 3126/E6,3/50mm)/2 pcs
- 5997708121166 PH1-3 bit for drillm. (DIN 3126/E6,3/50mm)/3 pcs

- 5997708121173 TX10 bit for drillmachine (DIN 3126/C6,3/25mm)/2 pcs
- 5997708121180 TX15 bit for drillmachine (DIN 3126/C6,3/25mm)/2 pcs
- 5997708121197 TX20 bit for drillmachine (DIN 3126/C6,3/25mm)/2 pcs
- 5997708121203 TX25 bit for drillmachine (DIN 3126/C6,3/25mm)/2 pcs
- 5997708121210 TX30 bit for drillmachine (DIN 3126/C6,3/25mm)/2 pcs
- 5997708121227 TX40 bit for drillmachine (DIN 3126/C6,3/25mm)/2 pcs
- 5997708121234 TX10-20 bit for drillm. (DIN 3126/C6,3/25mm)/3 pcs
- 5997708121241 TX25-40 bit for drillm. (DIN 3126/C6,3/25mm)/3 pcs

- 5997708121258 SC (0,5x3//0,6x3,5) / (DIN3126/C6,3/25mm)/2 pcs
- 5997708121265 SC (0,6x4,5//0,8x4,0) / (DIN3126/C6,3/25mm)/2 pcs
- 5997708121272 SC (0,8x5,5//1,0x5,5) / (DIN3126/C6,3/25mm)/2 pcs
- 5997708121289 SC (1,2x6,5//1,6x8,0) / (DIN3126/C6,3/25mm)/2 pcs

- 5997708121296 SC (0,5x3//0,6x3,5) / (DIN3126/C6,3/50mm)/2 pcs
- 5997708121302 SC (0,6x4,5//0,8x4,0) / (DIN3126/C6,3/50mm)/2 pcs
- 5997708121319 SC (0,8x5,5//1,0x5,5) / (DIN3126/C6,3/50mm)/2 pcs
- 5997708121326 SC (1,2x6,5//1,6x8,0) / (DIN3126/C6,3/50mm)/2 pcs

- 5997708121333 PH1/SC4,5 (DIN 3126/E6,3/60mm)/2 pcs
- 5997708121340 PH2/SC5,5 (DIN 3126/E6,3/60mm)/2 pcs

- 5997708121357 SK2/3 (DIN 3126/C6,3/25mm)/2 pcs
- 5997708121364 SK4/5 (DIN 3126/C6,3/25mm)/2 pcs
- 5997708121371 SK6/8 (DIN 3126/C6,3/25mm)/2 pcs

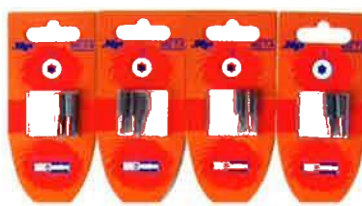

Drills, slotmilling tools, chisels, chucks

HSS drill for drillmachine

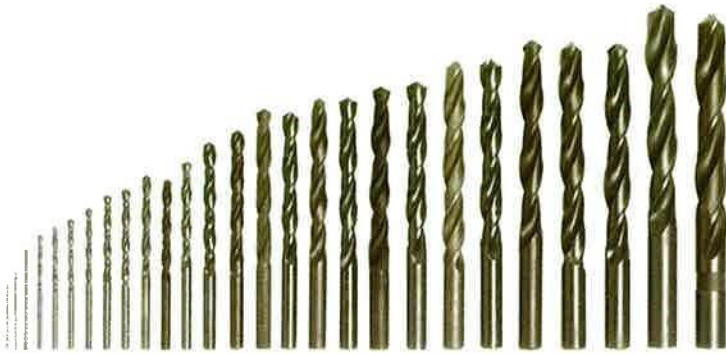

5997708107665	HSS Twist drill DIN 338 RN	1.0 / 2 pcs
5997708107672	HSS Twist drill DIN 338 RN	1.5 / 2 pcs
5997708107689	HSS Twist drill DIN 338 RN	2.0 / 2 pcs
5997708107696	HSS Twist drill DIN 338 RN	2.5 / 2 pcs
5997708107702	HSS Twist drill DIN 338 RN	3.0 / 2 pcs
5997708107719	HSS Twist drill DIN 338 RN	3.2 / 2 pcs
5997708107726	HSS Twist drill DIN 338 RN	3.5 / 2 pcs
5997708107733	HSS Twist drill DIN 338 RN	4.0 / 2 pcs
5997708107740	HSS Twist drill DIN 338 RN	4.2
5997708107757	HSS Twist drill DIN 338 RN	4.5
5997708107764	HSS Twist drill DIN 338 RN	4.8
5997708107771	HSS Twist drill DIN 338 RN	5.0
5997708107788	HSS Twist drill DIN 338 RN	5.5
5997708107795	HSS Twist drill DIN 338 RN	6.0
5997708107801	HSS Twist drill DIN 338 RN	6.5
5997708107818	HSS Twist drill DIN 338 RN	7.0
5997708107825	HSS Twist drill DIN 338 RN	7.5
5997708107832	HSS Twist drill DIN 338 RN	8.0
5997708107849	HSS Twist drill DIN 338 RN	8.5
5997708107856	HSS Twist drill DIN 338 RN	9.0
5997708107863	HSS Twist drill DIN 338 RN	9.5
5997708107870	HSS Twist drill DIN 338 RN	10.0
5997708107887	HSS Twist drill DIN 338 RN	10.5
5997708107894	HSS Twist drill DIN 338 RN	11.0
5997708107900	HSS Twist drill DIN 338 RN	11.5
5997708107917	HSS Twist drill DIN 338 RN	12.0
5997708107924	HSS Twist drill DIN 338 RN	12.5
5997708107931	HSS Twist drill DIN 338 RN	13.0
5997708107948	HSS Twist drill DIN 338 RN	14.0
5997708107955	HSS Twist drill DIN 338 RN	15.0
5997708107962	HSS Twist drill DIN 338 RN	16.0

5997708110054	HSS Twist drill	1.0 / 6 pcs / DIY
5997708110061	HSS Twist drill	1.5 / 6 pcs / DIY
5997708110078	HSS Twist drill	2.0 / 6 pcs / DIY
5997708110085	HSS Twist drill	3.0 / 6 pcs / DIY
5997708110092	HSS Twist drill	3.2 / 6 pcs / DIY
5997708110108	HSS Twist drill	4.0 / 6 pcs / DIY
5997708110115	HSS Twist drill	4.2 / 6 pcs / DIY
5997708110122	HSS Twist drill	6.0 / 3 pcs / DIY
5997708110139	HSS Twist drill	8.0 / 3 pcs / DIY
5997708110146	HSS Twist drill	10.0 / 3 pcs / DIY

HSS ECO Twist drill / DIN 1897 RN / INOX-NIROSTA / COBALT

5997708108044	HSS Cobalt drill	2.0
5997708108051	HSS Cobalt drill	2.5
5997708108068	HSS Cobalt drill	3.0
5997708108075	HSS Cobalt drill	3.2
5997708108082	HSS Cobalt drill	3.5
5997708108099	HSS Cobalt drill	4.0
5997708108105	HSS Cobalt drill	4.2
5997708108112	HSS Cobalt drill	4.5
5997708108129	HSS Cobalt drill	4.8
5997708108136	HSS Cobalt drill	5.0
5997708108143	HSS Cobalt drill	5.5
5997708108150	HSS Cobalt drill	6.0
5997708108167	HSS Cobalt drill	7.0
5997708108174	HSS Cobalt drill	8.0
5997708108181	HSS Cobalt drill	10.0

HM masonry drill

Long Life (LL) / Standard long

5997708108228	HM Masonry drill LL	3.0
5997708108235	HM Masonry drill LL	4.0
5997708108242	HM Masonry drill LL	5.0
5997708108259	HM Masonry drill LL	6.0
5997708108266	HM Masonry drill LL	7.0
5997708108273	HM Masonry drill LL	8.0
5997708108280	HM Masonry drill LL	10.0
5997708108297	HM Masonry drill LL	12.0
5997708108303	HM Masonry drill LL	14.0
5997708108310	HM Masonry drill LL	16.0
5997708108327	HM Masonry drill LL	18.0
5997708108334	HM Masonry drill LL	20.0

HM Masonry drill / Long Life (LL) / 200 mm long

5997708108341	HM Masonry drill 200 LL	6.0
5997708108358	HM Masonry drill 200 LL	8.0
5997708108365	HM Masonry drill 200 LL	10.0
5997708108372	HM Masonry drill 200 LL	12.0

HM Masonry drill / Long Life (LL) / 400 mm long

5997708108389	HM Masonry drill 400 LL	10.0
5997708108396	HM Masonry drill 400 LL	12.0
5997708108402	HM Masonry drill 400 LL	14.0
5997708108419	HM Masonry drill 400 LL	16.0
5997708108426	HM Masonry drill 400 LL	18.0
5997708108433	HM Masonry drill 400 LL	20.0



HM professional concrete drill

5997708108440	Profi concrete drill	4.0
5997708008457	Profi concrete drill	5.0
5997708108464	Profi concrete drill	6.0
5997708108471	Profi concrete drill	8.0
5997708108488	Profi concrete drill	10.0
5997708108495	Profi concrete drill	12.0
5997708108501	Profi concrete drill	14.0
5997708108518	Profi concrete drill	16.0



Forstner Drill

5997708109096	Forstner Drill	15.0
5997708109102	Forstner Drill	20.0
5997708109119	Forstner Drill	25.0
5997708109126	Forstner Drill	26.0
5997708109133	Forstner Drill	30.0
5997708109140	Forstner Drill	35.0
5997708109157	Forstner Drill	40.0



Drills, slotmilling tools, chisels, chucks

SDS Hammer drill



5997708108587 110x050 SDS Hammer drill 5.0
 5997708108594 110x050 SDS Hammer drill 6.0
 5997708108600 110x050 SDS Hammer drill 8.0
 5997708108617 110x050 SDS Hammer drill 10.0

5997708108624 160x100 SDS Hammer drill 5.0
 5997708108631 160x100 SDS Hammer drill 5.5
 5997708108648 160x100 SDS Hammer drill 6.0
 5997708108655 160x100 SDS Hammer drill 7.0
 5997708108662 160x100 SDS Hammer drill 8.0
 5997708108679 160x100 SDS Hammer drill 10.0
 5997708108686 160x100 SDS Hammer drill 12.0
 5997708108693 160x100 SDS Hammer drill 14.0

5997708108709 210x150 SDS Hammer drill 6.0
 5997708108716 210x150 SDS Hammer drill 8.0
 5997708108723 210x150 SDS Hammer drill 10.0
 5997708108730 210x150 SDS Hammer drill 12.0
 5997708108747 210x150 SDS Hammer drill 14.0
 5997708108754 210x150 SDS Hammer drill 16.0

5997708108761 260x200 SDS Hammer drill 6.0
 5997708108778 260x200 SDS Hammer drill 8.0
 5997708108785 260x200 SDS Hammer drill 10.0
 5997708108792 260x200 SDS Hammer drill 12.0
 5997708108808 260x200 SDS Hammer drill 14.0
 5997708108815 260x200 SDS Hammer drill 16.0
 5997708108822 260x200 SDS Hammer drill 18.0
 5997708108839 260x200 SDS Hammer drill 20.0

5997708108846 300x250 SDS Hammer drill 6.0
 5997708108853 300x250 SDS Hammer drill 8.0
 5997708108860 300x250 SDS Hammer drill 10.0
 5997708108877 300x250 SDS Hammer drill 12.0
 5997708108884 300x250 SDS Hammer drill 14.0
 5997708108891 300x250 SDS Hammer drill 16.0
 5997708108907 300x250 SDS Hammer drill 18.0
 5997708108914 300x250 SDS Hammer drill 20.0

5997708108921 450x400 SDS Hammer drill 8.0
 5997708108938 450x400 SDS Hammer drill 10.0
 5997718108945 450x400 SDS Hammer drill 12.0
 5997708108952 450x400 SDS Hammer drill 14.0
 5997708108969 450x400 SDS Hammer drill 16.0
 5997708108976 450x400 SDS Hammer drill 18.0
 5997708108983 450x400 SDS Hammer drill 20.0

5997708110153 110x 6.0 SDS Hammer drill / DIY
 5997708110160 110x 8.0 SDS Hammer drill / DIY
 5997708110177 160x 6.0 SDS Hammer drill / DIY
 5997708110184 160x 8.0 SDS Hammer drill / DIY
 5997708110191 160x10.0 SDS Hammer drill / DIY
 5997708110207 210x 8.0 SDS Hammer drill / DIY
 5997708110214 210x10.0 SDS Hammer drill / DIY
 5997708110221 210x12.0 SDS Hammer drill / DIY



SDS Chisel

5997708107979 SDS nibbed chisel 250
 5997708107986 SDS flat chisel 250/20
 5997708107993 SDS wide chisel 250/40
 5997708108006 SDS groove chisel 250/22

Drills, slotmilling tools, chisels, chucks

CV Wood drill

5997708108990	CV Wood drill	3.0
5997708109003	CV Wood drill	4.0
5997708109010	CV Wood drill	5.0
5997708109027	CV Wood drill	6.0
5997708109034	CV Wood drill	7.0
5997708109041	CV Wood drill	8.0
5997708109058	CV Wood drill	10.0
5997708109065	CV Wood drill	12.0
5997708109072	CV Wood drill	14.0
5997708109089	CV Wood drill	16.0

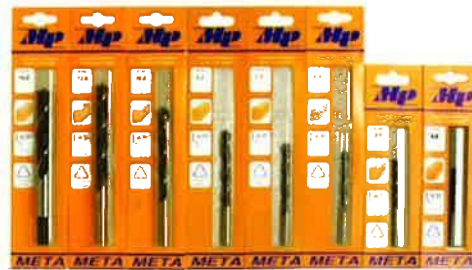

HM Glass drill

5997708108525	Glass drill	3.0
5997708108532	Glass drill	4.0
5997708108549	Glass drill	5.0
5997708108556	Glass drill	6.0
5997708108563	Glass drill	8.0
5997708108570	Glass drill	10.0



Drills, slotmilling tools, chisels, chucks

Tile drills



5997708122941 - Ø 33 Tile drill with adaptor
5997708122958 - Ø 53 Tile drill with adaptor
5997708122965 - Ø 67 Tile drill with adaptor
5997708122972 - Ø 73 Tile drill with adaptor
5997708122989 - Ø 83 Tile drill with adaptor
5997708122996 - Ø 103 Tile drill with adaptor

5997708123078 Ø 33 Tile drill
5997708123109 Ø 53 Tile drill
5997708123061 Ø 67 Tile drill
5997708123054 Ø 73 Tile drill
5997708123047 Ø 83 Tile drill
5997708123030 Ø 103 Tile drill

5997708123092 Adaptor for Tile drill / Ø 33-83
5997708123085 Adaptor for Tile drill / Ø 33-103

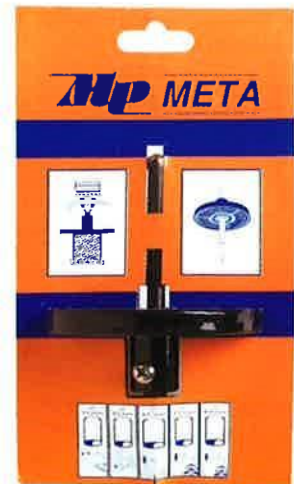

Drills, slotmilling tools, chisels, chucks

Forstner HSS Slotmilling tool

- 5997708105241 HSS Slotmilling tool D10, L19, SFT8 (6)
- 5997708105258 HSS Slotmilling tool D20, L17, SFT8 (12)
- 5997708105265 HSS Slotmilling tool D8, L19, SFT8 (5)
- 5997708105272 HSS Slotmilling tool D16, L17, SFT8 (10)
- 5997708105289 HSS Slotmilling tool D6, L16, SFT8 (4)
- 5997708105296 HSS Slotmilling tool D12, L19, SFT8 (7)
- 5997708105302 HSS Slotmilling tool D5, L12, SFT8 (3)
- 5997708105319 HSS Round slotmilling tool D16, R8, SFT8 (21)
- 5997708105326 HSS Wedgeformed milling tool S8, 60°/D11 (25)
- 5997708105333 HSS Slotmilling tool D14, L17, SFT8 (8)
- 5997708105340 HSS Semicircular milling tool with directing lap D21, R8, S8 (45)
- 5997708105357 HSS Flanged semicircular milling tool with dir. tap D28, R9, 5, S8



Chuck, chuck key

- 5997708122125 A type chuck 0.5-6.5
- 5997708122132 A type chuck 1.0-10.0
- 5997708122149 A type chuck 1.5-13.0
- 5997708122156 A type chuck 3.0-16.0
- 5997708122163 A type chuck 5.0-20.0

- 5997708122170 B type chuck 0.5-6.5 / Profi
- 5997708122187 B type chuck 1.0-10.0 / Profi
- 5997708122194 B type chuck 1.5-13.0 / Profi
- 5997708122200 B type chuck 3.0-16.0 / Profi
- 5997708122217 B type chuck 5.0-20.0 / Profi

- 5997708122224 Automatic chuck / 1.0-10.0
- 5997708122231 Automatic chuck / 1.5-13.0

- 5997708122262 Chuck key / 4 mm
- 5997708122279 Chuck key / 6 mm
- 5997708122286 Chuck key / 8 mm
- 5997708122293 Chuck key / 10 mm



Sets



Sets

- 5997708103414 BS Fret saw for metal / 6 pcs
- 5997708103421 BD Fret saw for metal / 6 pcs
- 5997708103445 BS Fret saw for wood / 6 pcs
- 5997708103452 BD Fret saw for wood / 6 pcs

- 5997708121029 BS Fret saw for metal and wood / 10 pcs (A)
- 5997708121036 BD Fret saw for metal and wood / 10 pcs (C)
- 5997708121043 BS Fret saw for metal and wood / 10 pcs (B)

Carpentering sets

- 5997708110801 Router bit set / 5 pcs / DIY
- 5997708110818 Forstner drill set 15.0-35.0 / 5 pcs / DIY
- 5997708110894 HSS Twist drill set / 5 pcs / DIY
- 5997708110900 Masonry drill set / 5 pcs / DIY
- 5997708110917 Wood drill set / 5 pcs / DIY
- 5997708110924 Combi drill set / 9 pcs / DIY
- 5997708110931 Masonry drill set 200mm / 3 pcs / DIY
- 5997708110948 Masonry drill set 400mm / 3 pcs / DIY
- 5997708110955 Pin stone set / 5 pcs / DIY
- 5997708110962 Rotary rasp set / 5 pcs / DIY
- 5997708110986 Bit set / 7 pcs / DIY
- 4022202040307 Drill + plug set

- 5997708100253 Orientable drill holder





Contents

Sand papers, abrasive clothes	4
Sand papers, abrasive clothes	5
Sand papers, abrasive clothes	6
Sand papers, abrasive clothes	7
Sand papers, abrasive clothes	8
Sand papers, abrasive clothes	9
Cut-off and grinding wheels.	10
Cut-off and grinding wheels.	11
Cut-off and grinding wheels.	12
Cut-off and grinding wheels.	13
Cut-off and grinding wheels.	14
Cut-off and grinding wheels.	15
Saws.	16
Saws.	17
Saws.	18
Saws.	19
Vitrified bonded grinding stones	20
Vitrified bonded grinding stones	21
Vitrified bonded grinding stones	22
Vitrified bonded grinding stones	23
Vitrified bonded grinding stones	24
Vitrified bonded grinding stones	25
Grinding discs	26
Grinding discs	27
Steel brushes, steel wire wheels	28
Bits	29
Drills, slotmilling tools , chisels, chucks	30
Drills, slotmilling tools , chisels, chucks	31
Drills, slotmilling tools , chisels, chucks	32
Drills, slotmilling tools , chisels, chucks	33
Drills, slotmilling tools , chisels, chucks	34
Drills, slotmilling tools , chisels, chucks	35
Sets	36
Elementwall	37

